

Rotadorm Low
Rotadorm Max Low



Instruction for use

Stand: 10/2025
(Rev. 2.2)

Content

1	Foreword	5
2	General notes	5
2.1	Used symbols	5
2.2	Type plate	7
2.3	Standards verification	8
3	Safety instructions	9
4	General product description	10
4.1	Intended purpose	10
4.2	Indication	10
4.3	Contraindication	10
4.4	Equipment features	11
5	Assembly information	12
5.1	Basic information for assembly	12
5.2	Dimensional sketch of the movement space	12
5.3	Mounting instructions anti-tilt brackets	13
5.4	Mounting the bed extensions	14
5.4.1	Option 1	14
5.4.2	Option 2	14
5.5	Mounting the pull handle	15
5.6	Disassembling the care bed	15
6	Operation	16
6.1	Operating the patient handle	16
6.2	Locking function	16
6.3	Operating the functions	17
6.4	Operating the turning function	17
6.5	Operating the brake castors	18
6.6	Patient lifting pole with handle	18
6.7	Operating instructions	19
6.8	Mattresses approved for use	20
7	Ambient conditions	20
7.1	Storage conditions	21
7.2	Operating conditions	21
8	Technical data	21
9	Used materials	22

10	Service and care	22
11	Service life of the product.....	22
12	Disinfection	22
12.1	Specifications of detergents and disinfectants	23
13	Operational faults and solutions.....	23
14	Recommended accessories.....	24
15	Maintenance	24
15.1	Legal basis	24
15.2	Maintenance intervals	24
15.3	Spare parts.....	24
15.4	Notes on documentation	25
16	Reuse	25
17	Disposal.....	25
17.1	Disposal of the device	25
17.2	Disposal of the electrical components.....	25
17.3	Disposal of the packaging	25
18	Declaration of Conformity	26

List of figures

Figure 1: Exemplary type plate	7
Figure 2: Dimensional sketch of the movement area of the Rotadorm Low.....	12
Figure 3: Mounting sequence anti-tilt bracket	13
Figure 4: Assembly of the head part extensions (210 cm lying surface length)	14
Figure 5: Assembly of the foot part extension (220 cm lying surface length)	14
Figure 6: Raster position for adjusting the footrest (220 cm lying surface length)	15
Figure 7: Sequence for mounting the access instead of the mattress support bracket	15
Figure 8: Removable patient handle.....	16
Figure 9: Locking box	16
Figure 10: Patient hand control	17
Figure 11: Bed in the get up position.....	17
Figure 12: Exemplary castors in braked and unbraked condition.....	18
Figure 13: Patient lifting pole mount at the head end.....	19
Figure 14: Adjustable grab handle	19

List of tables

Table 1: Used symbols	7
Table 2: Standards verification	8
Table 3: Dimensions to the dimensional sketch of the movement space	13
Table 4: Extension options.....	14
Table 5: Storage conditions	21
Table 6: Operating conditions.....	21
Table 7: Technical data	22
Table 8: Operational faults and solutions.....	23
Table 9: Recommended accessories.....	24

1 Foreword

Dear customer!





We would like to thank you for the trust you have placed in us and for purchasing our product. We have manufactured this medical product with great care.





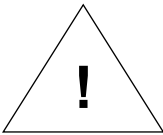

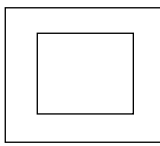

Please read the instructions for use carefully before using the product for the first time and always keep them close at hand.

Not all conceivable uses of the device can be covered in these instructions for use. For further information or in the event of problems that are not described in sufficient detail in these instructions for use, please contact your specialist dealer or medical supply store.

2 General notes

2.1 Used symbols

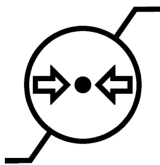
	<p>This warning sign indicates all instructions that are important for safety. Non-observance can lead to accidents or injuries.</p>
	<p>Manufacturer - Indicates the manufacturer of the medical device according to EU Directives 2017/745. The symbol must appear in close proximity to the symbol, together with the name and address of the manufacturer (i.e. the person who places the medical device on the market)</p>
	<p>Conformity symbol according to 2017/745 of the Medical Devices Directive</p>
	<p>Medical Device - Shows the medical device provided by the manufacturer in accordance with EU Directives 2017/745</p>
	<p>Device type B according to IEC 601-1 (Special protection against electric shock)</p>
	<p>Device of protection class II, protective insulation</p>

	<p>Dispose of electrical components in accordance with the legal requirements. Do not dispose of in household waste!</p>
	<p>Date of manufacture - indicates the date when the medical device was manufactured.</p>
	<p>Part number - displays the manufacturer's part number so that the medical device can be identified.</p>
	<p>Serial number - displays the manufacturer's serial number so that a specific medical device can be identified.</p>
	<p>Distributor - indicates the company that distributes the medical device at the location.</p>
	<p>Temperature Limit - indicates the temperature limits to which the medical device can be safely exposed.</p>
	<p>Humidity, Limit - indicates the humidity range to which the medical device can be safely exposed.</p>
	<p>Air Pressure, Limit - indicates the range of air pressure to which the medical device can be safely exposed.</p>
	<p>Observe instruction for use or electronic instruction for use - indicates to the user that it is necessary to observe the instruction for use.</p>

	Unique identifier of a medical device - displays a carrier containing information about a unique identifier of a medical device.
	Safe working load
	Max. patient weight
	Minimum body dimensions/weights of the patient

Table 1: Used symbols

2.2 Type plate

The type plate is attached to the head of the trolley frame. The nameplate allows the product to be clearly identified.

		ISKO KOCH GmbH 95448 Bayreuth Egerländer Str. 28
Safe working load:		
	13.01.2022	
	(01) 0 4251858 50276 5 (11) 220113 (21) 220100FB0005	

Figure 1: Exemplary type plate

Figure 1 shows an exemplary type plate. For the exact specifications of your product, please refer to the attached type plate.

2.3 Standards verification

The following national and international norms (standards) are used in the design and verification of the product, labeling and instructions for use.

Standard	Title	Edition
DIN EN 60601-2-52	<i>Medical electrical equipment - Part 2-52: Particular requirements for the safety of medical beds</i>	12/2010
DIN EN 60601-1-6	<i>Serviceability specification</i>	2010
EN 60601-1-2	<i>Electromagnetic compatibility</i>	2015
DIN EN ISO 10993	<i>Biological evaluation of medical devices - Part 1: Assessment and testing</i>	2010
DIN EN 1041	<i>Provision of information by the manufacturer of a medical device</i>	2008
DIN EN ISO 14971	<i>Medical devices - Application of risk management to medical devices</i>	2020

Table 2: Standards verification

3 Safety instructions

- You should read this instruction for use carefully (see Medical Devices Operator Ordinance under your national law) before using the bed. It contains important information for the safe and reliable use of the device. Keep the instruction for use for future reference.
- Safety, reliability and performance are guaranteed if the following instructions are observed and the device is used in an expert manner. As the operator, you must comply with the Medical Devices Operator Ordinance under your national law.
- The Rotadorm Low suitable for both home care (application environment 3, 4), here a maximum patient weight of 135 kg must be observed.
- Ensure that children only have access to the bed under supervision and that no children remain in the danger zone under the bed during its operation.
- The bed should only be set up by authorized personnel.
- The fuse on the installation side must not exceed 16A. Before connecting the device, please make sure that the voltage and frequency of your power supply correspond to the specifications on the type plate.
- Ensure a level standing surface when selecting the location for the bed.
- Provide a suitable floor covering if the bed must be moved frequently. Carpets, rugs and loosely laid floor coverings can be damaged or make it difficult to push.
- Connect the power plug firmly to the power socket. When doing so, lay the power supply cable on the floor. Make sure that the bed (especially when moving) does not rest on the cable with its castors. The cable must not be routed through the mechanics of the base! (danger of crushing)
- Damaged power cables can lead to life-threatening situations. These must be replaced immediately.
- Check the power cable for damage at regular intervals (weekly).
- Make sure that the electrical specifications of the device correspond to the local conditions at the installation site.
- When the hand control is not in use, make sure that it is hanging on the bed and not placed in the bed to prevent incorrect operation which could cause damage.
- If the patient is unattended, ensure that the bed is set at its lowest height to allow the easiest possible entry and exit.

4 General product description

4.1 Intended purpose

The Rotadorm Care is a medical device that can lead to the patient's renewed participation in his environment and minimize physical stress for both the patient and the caregiver. The Rotadorm Low is the next generation model.



4.2 Indication

The Rotadorm Low is an aid whose use is indicated:

- for people who are unable to get up or mobilize themselves independently in bed and sit on the edge of the bed
- to enable people to get up independently
- to enable independent transfer from bed to wheelchair
- to enable and support getting up in case of severely limited mobility or strain on the lumbar spine and joints
- for mobilization in case of extreme pain symptoms during passive movement
- in case of extensor spasticity caused by passive movement (e.g. MS)
- for people for whom the caregiver must be physically relieved in home care in order to make home care possible and ensure it in the long term
- for insured persons who are no longer spontaneously mobile, especially patients with QS symptoms, with a greatly increased risk of developing a pressure sore, or for the further treatment of an existing pressure sore
- in case of tetraplegia or advanced muscular dystrophy with preserved residual function of the legs, especially if regular changes of position of the upper body and legs are required
- for self-mobilization after stroke
- for seated positioning, e.g. in case of cardiac insufficiency

The indication for Rotadorm Low applies to all illnesses or disabilities in which the patient is unable to perform the movement sequence of getting up from lying to sitting with or without assistance due to his joints, low muscle strength or pain - or in which the assisting person is physically overloaded, e.g. due to his own illness.

4.3 Contraindication

In case of decubitus especially in the hip and leg area

- In case of extreme deformation and non-weight-bearing capacity of the lower extremities
- In case of massive cardiovascular problems
- In case of severe dizziness, which makes it impossible to stand up independently or partially independently.
- In case of severe anxiety

The caregiver must make sure that the user is mentally capable of handling an electrically adjustable care bed. Otherwise, all electrical functions on the bed must be switched off using the key switch and the hand control must also be secured against access by the patient.

4.4 Equipment features

The turning bed has the following electrical functions

- Electrical height adjustment
- Electrical head adjustment
- Electrical neck adjustment
- Electrical knee adjustment
- Electrical leg adjustment
- Electrical turning function

The drives for the adjustment functions consist of electromechanical linear motors with maintenance-free permanent lubrication. The drives are operated via a hand switch, which is connected to the control unit via a spiral cable. The bed has four single-braked castors.

The drives and the hand switch are galvanically isolated from the mains voltage and are operated with a low voltage (DC 24 V).

With a turning bed, the patient's personal space of action is maintained over a long period of time. The user can move and care for himself freely.

The stand-up function of the lying surface can be adjusted by the service staff specifically to the needs of the patient. A selection of the direction of rotation to the left or right is possible.

5 Assembly information

5.1 Basic information for assembly

The bed should only be assembled by authorised personnel. The fuse on the installation side must not exceed 16A.

Before connecting the device, please ensure that the voltage and frequency of your mains supply correspond to the specifications on the type plate.

Ensure that the bed is placed on a level surface when selecting its location. Ensure a suitable floor covering if the bed has to be moved frequently. Carpets, rugs and loosely laid floor coverings can be damaged or make it difficult to push the bed.

Connect the mains plug firmly to the mains socket. When doing so, lay the mains connection cable on the floor. When doing so, ensure that the bed (especially when moving) is not standing with its castors on the cable. The cable must not be fed through the mechanics of the bed base! (danger of crushing)



Damage to the electrical mains cable by running over it or clamping it can have fatal consequences.



Before moving the bed or dismantling it for transport, the mains connection cable must be wound up and secured to the intended device on the chassis.

5.2 Dimensional sketch of the movement space

For the rotating function of the lying surface, it is essential to keep the following space free for movement outside the nursing bed.

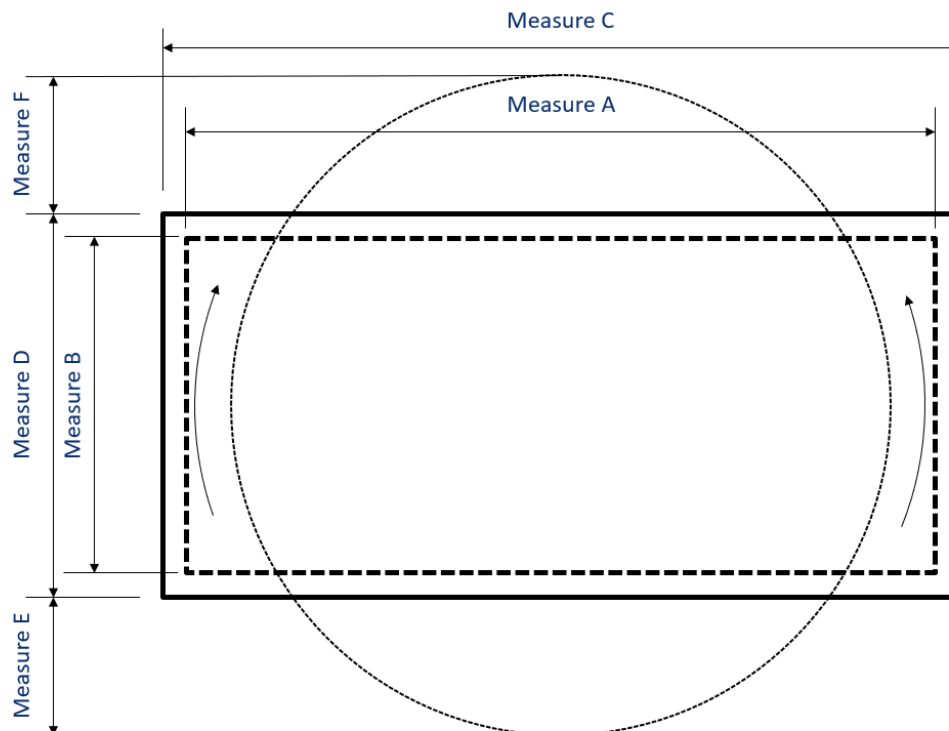

Figure 2: Dimensional sketch of the movement area of the Rotadorm Low

Type	SI-012-1
Measure A ^{*)}	200 cm
Measure B ^{*)}	85 cm
Measure C	205 cm
Measure D	99 cm
Measure E (head end)	30 cm
Measure F (foot end)	50 cm

Table 3: Dimensions to the dimensional sketch of the movement space



No objects, pieces of furniture or walls may interfere with the turning function within the specified range of motion. (Danger of crushing)

5.3 Mounting instructions anti-tilt brackets

(Rotadorm Max Low)

The anti-tilt supports are delivered separately with the Rotadorm Max Low. Therefore they must be mounted to the bed independently. The necessary components are attached to the chassis in a plastic foil. The anti-tilt brackets can be mounted with two grub screws at the bed. Figure 3 below shows the necessary assembly steps to mount the anti-tilt brackets at the bed. Plug in the anti-tilt brackets into the intended position at the chassis until the grub screw is reached. Screw tight the grub screw until the anti-tilt bracket is fixed. Repeat this process four times for all the brackets.



Figure 3: Mounting sequence anti-tilt bracket

5.4 Mounting the bed extensions

The Rotadorm Low can be used in lengths of 200 cm, 210 cm and 220 cm. For this purpose, it is necessary to ensure correct assembly of the foot or head part extension.

Option	Article number	Lying surface length
1	SI-012-21	210 cm
2	SI-022-22	220 cm

Table 4: Extension options

5.4.1 Option 1

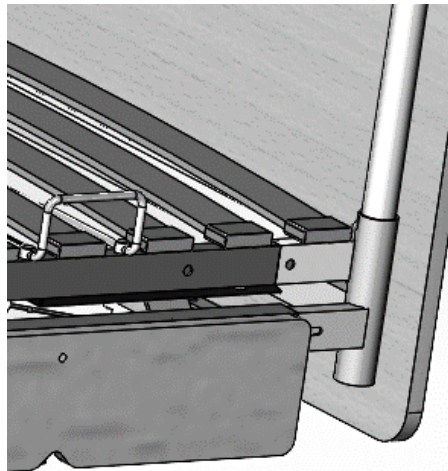

Figure 4: Assembly of the head part extensions (210 cm lying surface length)

The head part extension is to be mounted on the head part of the 210 cm variant according to Figure 4.

5.4.2 Option 2

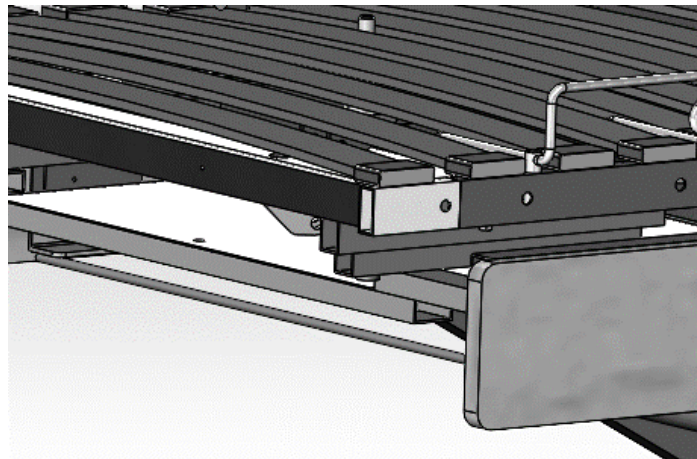

Figure 5: Assembly of the foot part extension (220 cm lying surface length)

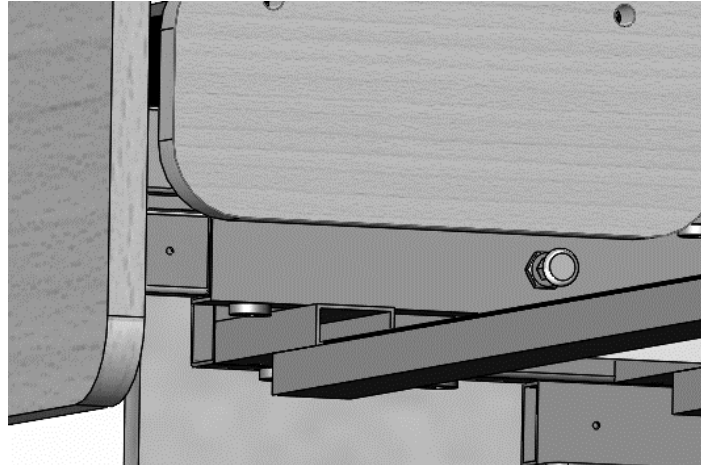

Figure 6: Raster position for adjusting the footrest (220 cm lying surface length)

For the 220 cm version, the foot part extension must be inserted into the lower leg support as shown in Figure 5. The foot section extension must be inserted all the way to the end. Here, you must first pull out the footrest to the next locking position so that you create the necessary space for the foot part extension. You will find the catches below the lower leg rest (see Figure 6). Make sure here that the latches are engaged. The extension part must be secured by the set screws.

5.5 Mounting the pull handle

When mounting the pull handle, the mattress holder mounted on the head side must be removed. To do this, loosen the screw connection and insert the pull handle in the existing holes. The standard screws can be used for reattachment. (cf. Figure 7)



Figure 7: Sequence for mounting the access instead of the mattress support bracket

5.6 Disassembling the care bed

If necessary, for example for transport, the care beds can be easily dismantled as described, but in reverse order. Re-assembling the bed after dismantling should only be done by authorized personnel.

6 Operation

6.1 Operating the patient handle



Figure 8: Removable patient handle

The patient handle is used to hold or support the patient during the standing-up process. It is only intended for use during the standing-up process. The handle must be screwed tight via the grub screws and must also have latched pull latches. (cf. Figure 8)



Retaining brackets must always be properly mounted when in use.

6.2 Locking function

All turning beds are equipped with a safety shut-off system. The integrated lockout knob allows the user to lock or unlock the electrical functions directly on the locking box.



Figure 9: Locking box

6.3 Operating the functions

All electrical functions are operated by the manual push buttons. Each button is labelled according to its function.

If necessary, an authorized dealer can adapt all the functions of the motor movements exactly to your wishes or care requirements and set the individual positions of the lying surface and store them in the electronic control of the program sequence.

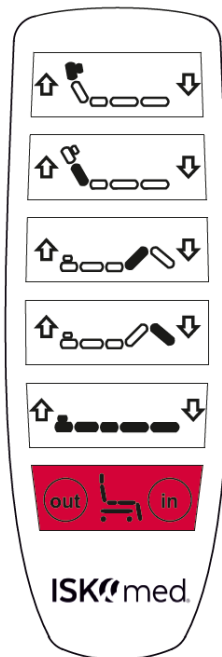

Figure 10: Patient hand control

6.4 Operating the turning function

When using the turning function, the lying surface automatically moves into a suitable position to allow the user to get out of the bed easily (cf. Figure 11).



Figure 11: Bed in the get up position

When the button "**Get in**" is pressed, the bed goes from the sitting-standing up position back into the lying position, while the footrest remains slightly raised and does not go completely into the horizontal position.

Pressing the button "**Get out**":

- The height motor drives to a preset height as starting position for turning

- The knee bend and headrest motors drive at the same time to a predefined sitting position, whereby the legs lie over the edge of the bed and the seat back is inclined around 45° to the rear.
- Then a further drive turns the lying surface to angle of 90° to the chassis
- After the 90° position has been reached, the height of the lying surface is corrected upwards
- Then the kneebend and the headrest simultaneously bring the lying surface to the standing up position
- Finally, the neck support is raised to make it easier to get out of bed, then the turning process is completed

Pressing the button "**Get in**":

- The height motor drives up into the preset starting position to turn back.
- The knee bend and head rest motors simultaneously go into a predefined sitting position (see above)
- Once it has arrived in the sitting position, the lying surface turns back parallel to the chassis
- The knee bend and head rest motors simultaneously drive into the lying position, while the head rest remains somewhat raised and does not completely drive back into the horizontal position.



Keep the buttons pressed until the turning process has completely ended.

(No more noise can be heard from the motors)



For lateral exit, the holder of the handle must be unscrewed. Alternatively, a cover (SI-011.80.725) can be used.

6.5 Operating the brake castors

The bed should always be braked at the place of installation with the help of the castor brake.



Figure 12: Exemplary castors in braked and unbraked condition

6.6 Patient lifting pole with handle

There is a mounting for the lifting pole on both sides of the lying surface at the head of our care beds. When fitting the lifting pole, ensure that lifter tube with the metal bolt is pushed far enough into the socket bushing so that the metal bolt is fully located in the recessed slot on the socket bushing. Thus the lifting pole is fixed in its position and can not be swung out over the lying surface (cf. Figure 13)

The included grab handle is used for the user to stand upright and can be individually adjusted to the correct height with the webbing.

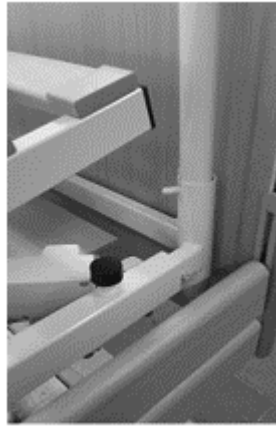

Figure 13: Patient lifting pole mount at the head end



The lifter is not suitable for therapeutic purposes.



The maximum load capacity of the lifter is 75 Kg



The metal bolt on the lifter tube must always be located in the recess slot. Danger of toppling over!



Check the grab handle and the webbing strap for damage at regular intervals. Damaged parts should be changed immediately!

The grab handle which is delivered is designed to assist the user to sit up and can be individually adjusted to the correct height with the webbing strap and the adjusting buckle (cf. Figure 14). The range of adjustment is from 670mm to 870mm. (Measured without mattress)

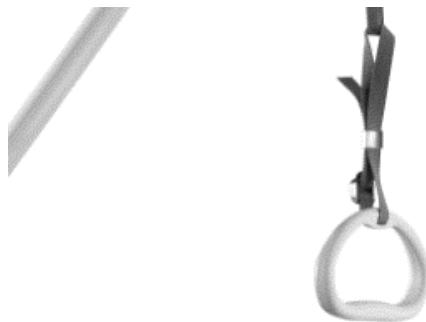

Figure 14: Adjustable grab handle

6.7 Operating instructions

- After the bed has been assembled and before it is used by a patient, check that all connections and the whole bed itself are firmly secured.
- Check that all drives are working faultlessly.
- If a care bed is not fully capable of functioning, it should be taken out of use immediately.

- Make sure that there are no objects such as waste paper bins, side tables, chairs etc. in the movement space of the bed.
- In order to avoid the risk of injury, it is not permitted for any part of the patient's body to protrude out from the lying surface, nor for feet to rest on the bed underframe when operating the adjustment functions.
- Before moving the bed, the mains plug should be removed from the socket in order to avoid damage to the electrics.
- When there is a patient in the bed, the maximum height of a threshold over which the bed can be pushed is 2 cm.
- Make sure to maintain the duty cycle. Never make lengthy and unnecessary electrical adjustments. Once the thermal protection switch in the control unit has been triggered after 6 min/h, the control unit has to be replaced by an authorized specialist!



The installation of ancillary equipment such as insulin pumps, ventilators etc. is not permitted unless equipotential bonding has been made in advance.



The cables for any ancillary equipment must not be led under the base of the bed! (Danger of crushing)

6.8 Mattresses approved for use

This bed is intended to be used with a divided, fire retardant mattress according to DIN 13014 and DIN 597, with a minimum volume weight of 35 Kg/m³ (RG35), a compression resistance of min. 4.2 kPa, a maximum height of 12 cm, a minimum width of 88 cm and a minimum length of 197 cm (mattress and foot block together).



For safety reasons, a distance of 22 cm must be maintained between the upper edge of the mattress (unloaded) and the upper edge of the uppermost wooden side rails (side rails in upper position).



Mattresses with high volume weights are only permitted if the weight of the mattress and the patient combined does not exceed the safe working load of the bed.

7 Ambient conditions

According to DIN EN 60601-2-52, the medical device can be used in the following application environment:

Application environment 3:

Long-term care in a medical setting where medical supervision is required and monitoring is provided as necessary; an ME device may be provided for a medical procedure to maintain, improve, or support the patient's condition.

Application environment 4:

ME device to alleviate or compensate for an injury, disability or illness in home care.

A maximum noise level of 49 dB (A) occurs during adjustment of the electric drives.

7.1 Storage conditions



Storage conditions	min. -10 °C max. +50 °C	
Relative humidity	min. 20 % max. 80 %	
Air pressure (at altitude ≤ 3000 m)	min. 700 hPa max. 1060 hPa	

Table 5: Storage conditions

7.2 Operating conditions



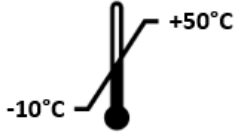

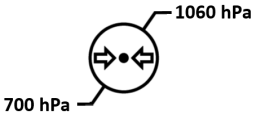
Operating conditions	min. +5 °C max. +40 °C	
Relative humidity	min. 20 % max. 80 %	
Air pressure (at altitude ≤ 3000 m)	min. 700 hPa max. 1060 hPa	

Table 6: Operating conditions

8 Technical data

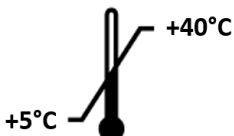
Designation	Typ SI-012-1 / SI-022-1
Nominal voltage	~230 V/50Hz
Rated power	200 VA
Device type B according to IEC 601-1	
Protection class	
Sound power level	63 dB(A)
IP protection class for drive components:	
Control unit	IP 54
Manual button unit	IP 54
Actuators	IP 54
Duty cycle switch on duration 10%	maximal 6 min/h
Max. patient weight	SI-012-1: 135 kg SI-022-1: 180 kg
Safe working load	SI-012-1: 175 kg

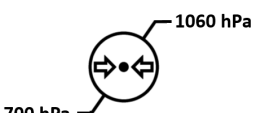
	SI-022-1: 220 kg
Dimensions of lying area	200/210/220cm x 85cm
Minimum lower leg length of the patient	38 cm
Dimensions of the nursing bed:	
Total weight including patient lifter and wooden parts	195 kg / 215 kg
Height adjustment (measured without mattress)	from 34 to 78 cm
Adjustment angle thigh support	0° to 43°
Adjustment angle head rest	0° to 83°
Adjustment angle neck rest	0° to 29°

Table 7: Technical data



Reparations may only be carried out by ISKO qualified personnel or by persons authorized and trained by ISKO with comprehensive product knowledge. In case of non-compliance with this provision, any warranty and liability claims will be rejected.

9 Used materials

The medical device is manufactured as a welded tubular steel construction. The surfaces are powder coated or galvanized. All wooden parts are either laminated or lacquered. The surfaces of this product are unthinkable for the skin from the point of view of health.

10 Service and care

All household cleaners without ammonia and scouring agents are permissible for cleaning the tube parts, the lying surface and the wooden parts with a damp cloth. Solvents (e.g. nitro) destroy the coating of the tubes and the lying surface!

Mechanical cleaning (e.g. scraping, sanding) or jet cleaning of the bed is not permitted. All pivots of the moving parts, including the bearing eyes on the adjustment device, are provided with maintenance-free slide bearings and must not be oiled or greased.

11 Service life of the product

At an expected average level of use in home care, the service life of the bed is approximately 10 years. Lack of maintenance and excessive stress on the product can significantly reduce the service life of the bed. The expected service life in professional nursing home use is approx. 7 years.

12 Disinfection

- In order to ensure that the bed functions properly, each ISKO bed should be cleaned, disinfected and checked after each use so that it can be used again immediately.
- Improper cleaning/disinfection of the bed can cause hazards.
- Depending on the degree of soiling, we recommend cleaning the bed with a damp cloth or similar.
- For wipe and spray disinfection, disinfectants in their intended concentration can be used. (see manufacturer's instructions)
- The dilution ratio recommended by the manufacturers in the respective instructions for use must be used.

Solvents are not permitted.



Abrasives or scouring sponges must not be used.

12.1 Specifications of detergents and disinfectants

- The working solutions should normally be used freshly prepared.
- The concentrations given should not be exceeded or fallen below.
- They must not contain corrosive or caustic components.
- They must not contain any substances that alter the surface structure or the adhesion properties of the materials.
- Lubricants must not be attacked by cleaning and disinfecting agents.



Under no circumstances should soap or washing-active substances be added to the disinfectant. In the case of products containing alcohol, there is a risk of explosion and fire when applied over large areas.



The use of unsuitable detergents and disinfectants can cause damage to the surface coating for which ISKO KOCH GmbH cannot be held liable.

13 Operational faults and solutions

	Fault	Measure
1	None of the motors respond to the switch actuation.	Check plug connection between the hand control and control box. Check plug connection between the motor cables and control box. Check the plug connection of the power cord.
2	A motor does not respond to the switch actuation	Check plug connection between the motor cable and control box. Check plug connection between the hand control and control box.
3	The turning function does not respond to the manual switch actuation	Lower both side rails completely. Both end buttons must be pressed through the side rails. See also points 1 and 2
4	Error number 1,2 or 3	Reset/Initialization Hold down the second row of keys simultaneously (really simultaneously) and together until the interrupted signal tone changes to a continuous tone (after approx. 5 seconds). Immediately after the reset (simultaneous pressing of the 2nd row of keys), the first row of keys is held down simultaneously for initialization until a long signal tone sounds. During this process, the motors may search for their end position.

Table 8: Operational faults and solutions



For issues which cannot be rectified using the aforementioned instructions; any changes, new settings or repairs to the bed may only be implemented by the manufacturer directly, or by a workshop authorised by the manufacturer.

14 Recommended accessories

Article	Order number
Pillow clips	SI-038-0
Pull handle	SI-011.85.307
Cover for handle holder	SI-011.80.725
Table	SI-132-0

Table 9: Recommended accessories

15 Maintenance

15.1 Legal basis

The Medical Device Regulation (EU) 2017/745 (MDR) as well as national laws and regulations require operators of medical devices to ensure a safe operating condition of the medical device during the entire period of use.

15.2 Maintenance intervals

As a requirement of the Medical Device Operator Ordinance §4 (Maintenance), a thorough visual inspection (1), a functional test (2) and a current discharge test (3) must be performed in accordance with DIN EN 62353:2015-10 after the medical device has been in operation for at least two years.

(1) During the visual inspection, particular attention must be paid to the following points:

- tight fit of all screw connections
- mobility of the pivot points
- Checking the power supply cable for pinching or shearing points
- check of the strain relief of the power supply line

(2) During the functional test, special attention shall be paid to the following points:

- Function of all electrically operated movements
- Fully extend and retract all motors on the nursing bed (without mattress; without patient) until they switch off by themselves. (Limit switches in the motors must switch off with an audible click).
- Functionality of the brakes
- Mobility and function of the side rails
- Mobility of the triggers
- Check of the hand switch

Functional tests and current leakage tests may only be carried out by ISKO specialist personnel or by persons authorized and trained by ISKO with comprehensive product knowledge.

15.3 Spare parts

All spare parts for this medical device must be ordered from ISKO KOCH GmbH, stating the serial number, order number and article number (these can be found on the type plate attached to the medical device).

To ensure that the functional safety and any warranty claims remain valid, only original ISKO KOCH GmbH parts are to be used for the spare parts.

ISKO KOCH GmbH

Egerländer Straße 28

95448 Bayreuth

Tel.: +49(0)921/150845-0 (Monday – Thursday 8:00 – 17:00 pm & Friday 8:00 – 16:00 pm)

Fax: +49(0)921/150845-45

E-Mail: info@isko-koch.de

15.4 Notes on documentation

According to the Medical Device Operator Regulation and Medical Device Regulation (EU) 2017/745 (MDR), there is a documentation obligation for:

- Maintenance
- Incidents / near misses

If extraordinary hazards for the product are foreseeable at the installation site of the care bed (supply line lies on the floor; children playing; pets; ...), the electrical lines in particular must be constantly checked and suitable measures taken to avert hazards.

16 Reuse

Before each reuse of the care bed, a thorough visual and functional check of all electrically operated functions as well as a current leakage test according to DIN EN 62353:2015-10 must be performed as described under the item Maintenance intervals. The points on service and care & maintenance mentioned in the operating instructions must always be observed when cleaning the bed.

17 Disposal

17.1 Disposal of the device

Disposal of the device and accessories, if any, should be carried out in an environmentally friendly manner and in accordance with the legal regulations. Please adhere to the valid waste separation regulations! If there are any uncertainties in this matter, please contact your local municipality or waste disposal company.



17.2 Disposal of the electrical components

*if electrical components are included in the medical device

According to Directive 2012/19/EU - WEEE2, this medical device is classified as an electrical device. All electrical components are free of unauthorized ingredients classified as harmful according to RoHS II Directive 2011/65/EU. In addition, replaced electrical components must be disposed of in accordance with European directives (see Directive 2012/19/EU - WEEE2).

17.3 Disposal of the packaging

The EU Waste Framework Directive 2008/98/EC is decisive for the handling during the disposal of the packaging. Reusable materials must be fed into a recycling cycle in accordance with national regulations.

18 Declaration of Conformity

As the manufacturer, we declare under our sole responsibility that our turning beds complies with the basic requirements of the EC Directive for

Medical devices 2017/745, Annex II



ISKO KOCH GmbH

Egerländer Str. 28

95448 Bayreuth

